

# HERAIS Chairs



# Technology <<

FURNITURE





## GB8624-2012 Class B1 Test

**SGS**  
 Test Report No. SGL16100004916 Date: Oct 21, 2016 Page 1 of 4  
 AECORE SCIENTIFIC PRODUCTS COMPANY LIMITED  
 AGRICULTURE SCIENCE RESEARCH STATION, WUHEMEN ROAD, JIANGSU TONGJIYUAN DISTRICT,  
 WUXI CITY, JIANGSU PROVINCE, CHINA

The following sample(s) was/were submitted and identified on behalf of the client as:  
 Sample Description: Polypropylene Chair  
 Buyer Name: SGS  
 Sample Processing Date: Oct 21, 2016  
 Test Performing Date: Oct 21, 2016 to Oct 26, 2016

Sample Description	Test Result Summary	Remarks
GB 8624-2012 Fire classification for burning behavior of building materials and products, Chapter 5.2.3 (requirement for the performance for upholstered furniture and light furniture)	Class B1	Classification
GB 8624-2012 Fire classification for burning behavior of building materials and products, Chapter 5.2.3 (requirement for the performance for upholstered furniture and light furniture)	Class B1	Classification

Approved for and on behalf of:  
 SGS-CSTC Co., Ltd.

**SGS**  
 Test Report No. SGL16100004916 Date: Oct 21, 2016 Page 2 of 4  
 TESTS AND RESULTS

**Test Conditions:**  
 1. Test method: GB 8624-2012 Fire classification for burning behavior of building materials and products, Chapter 5.2.3 Table 4  
 2. Test method: GB 8624-2012 Fire classification for burning behavior of building materials and products, Chapter 5.2.3 Table 4  
 3. Test method: GB 8624-2012 Fire classification for burning behavior of building materials and products, Chapter 5.2.3 Table 4

Test Results	Requirement	Result
Heat release rate (HRR)	≤ 30 kW	34.8
Peak Power Total heat release (PPHRR)	≤ 300 kW	7.3
Maximum average density (MAD)	≤ 0.15 kg/m³	0.15
Smoke density (SD)	≤ 1.0 m³/m³	ND
Flame height (FH)	≤ 1.0 m	ND

Classification and effect: Class B1 of performance.  
 Classification and effect: Class B1 of performance.  
 Classification and effect: Class B1 of performance.

Approved for and on behalf of:  
 SGS-CSTC Co., Ltd.

**SGS**  
 Test Report No. SGL16100004916 Date: Oct 21, 2016 Page 3 of 4  
 Table 4. Classes of materials for the performance for upholstered furniture and light furniture

Class	Category	Test method(s)	Classification criteria
B1	Upholstered furniture	GB 8624-2012 GB 1709-2014	Heat release rate ≤ 30 kW; Peak Power Total heat release ≤ 300 kW; Maximum average density ≤ 0.15 kg/m³; Flame height ≤ 1.0 m; Smoke density ≤ 1.0 m³/m³
	Light furniture	Annex A	Heat release rate ≤ 30 kW; Peak Power Total heat release ≤ 300 kW; Maximum average density ≤ 0.15 kg/m³; Flame height ≤ 1.0 m; Smoke density ≤ 1.0 m³/m³
B2	Upholstered furniture	GB 8624-2012 GB 1709-2014	Heat release rate ≤ 30 kW; Peak Power Total heat release ≤ 300 kW; Maximum average density ≤ 0.15 kg/m³; Flame height ≤ 1.0 m; Smoke density ≤ 1.0 m³/m³
	Light furniture	Annex A	Heat release rate ≤ 30 kW; Peak Power Total heat release ≤ 300 kW; Maximum average density ≤ 0.15 kg/m³; Flame height ≤ 1.0 m; Smoke density ≤ 1.0 m³/m³

Approved for and on behalf of:  
 SGS-CSTC Co., Ltd.

**SGS**  
 Test Report No. SGL16100004916 Date: Oct 21, 2016 Page 4 of 4  
 PHOTO & VIDEO EVIDENCE

Approved for and on behalf of:  
 SGS-CSTC Co., Ltd.

# Colour

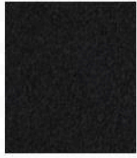

BK



4204



8314



7721U



1807U



9093



4010



310C



2659

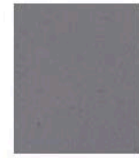

2706



# CH02 PU

PU Integral- Self skinning Foam/Anti-static series

Unprecedented master work certainly manifest humanities, a mini-field of precision physics is permeated with palace-grade feeling, prosperous and grand, moving and unrestrained; the forerunners predict the future; the new generation demonstrates majestic demeanor.





**CH02AP**



**CH02BP**



**CH02CP**



**CH02JP**



**CH02AS**



**CH02BS**



**CH02CS**



**CH02JS**



**CH02A**



**CH02B**



**CH02C**



**CH02J**



**CH02-1AP**



**CH02-1BP**



**CH02-1CP**



**CH02-1JP**



**CH02-1AS**



**CH02-1BS**



**CH02-1CS**



**CH02-1JS**



**CH02-1A**



**CH02-1B**



**CH02-2C**



**CH02-1J**



# CH01 PU

PU Integral- Self skinning Foam/Anti-static series

## Model:CH01-1DL

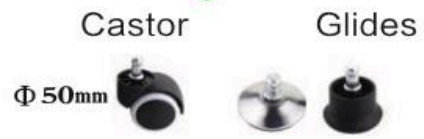
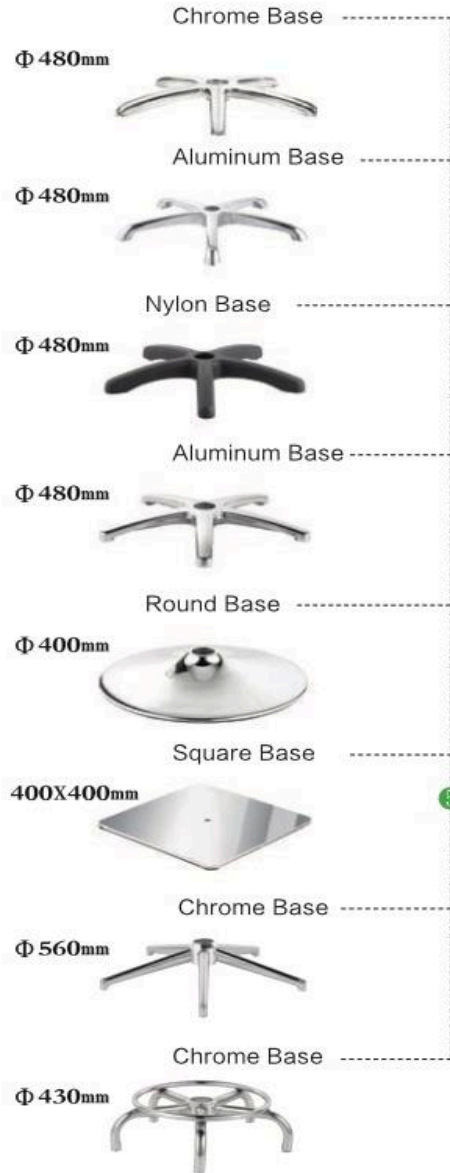

### Colour







**CH01A**



**CH01B**



**CH01C**



**CH01D**



**CH01-1A**



**CH01-1B**



**CH01-1C**



**CH01-1D**



**CH01H**



**CH01H1**



**CH01E**



**CH01-1E**



**CH01AL**



**CH01BL**



**CH01CL**



**CH01DL**



**CH01-1AL**



**CH01-1BL**



**CH01-1CL**



**CH01-1J**



**CH01HL**



**CH01-1G**

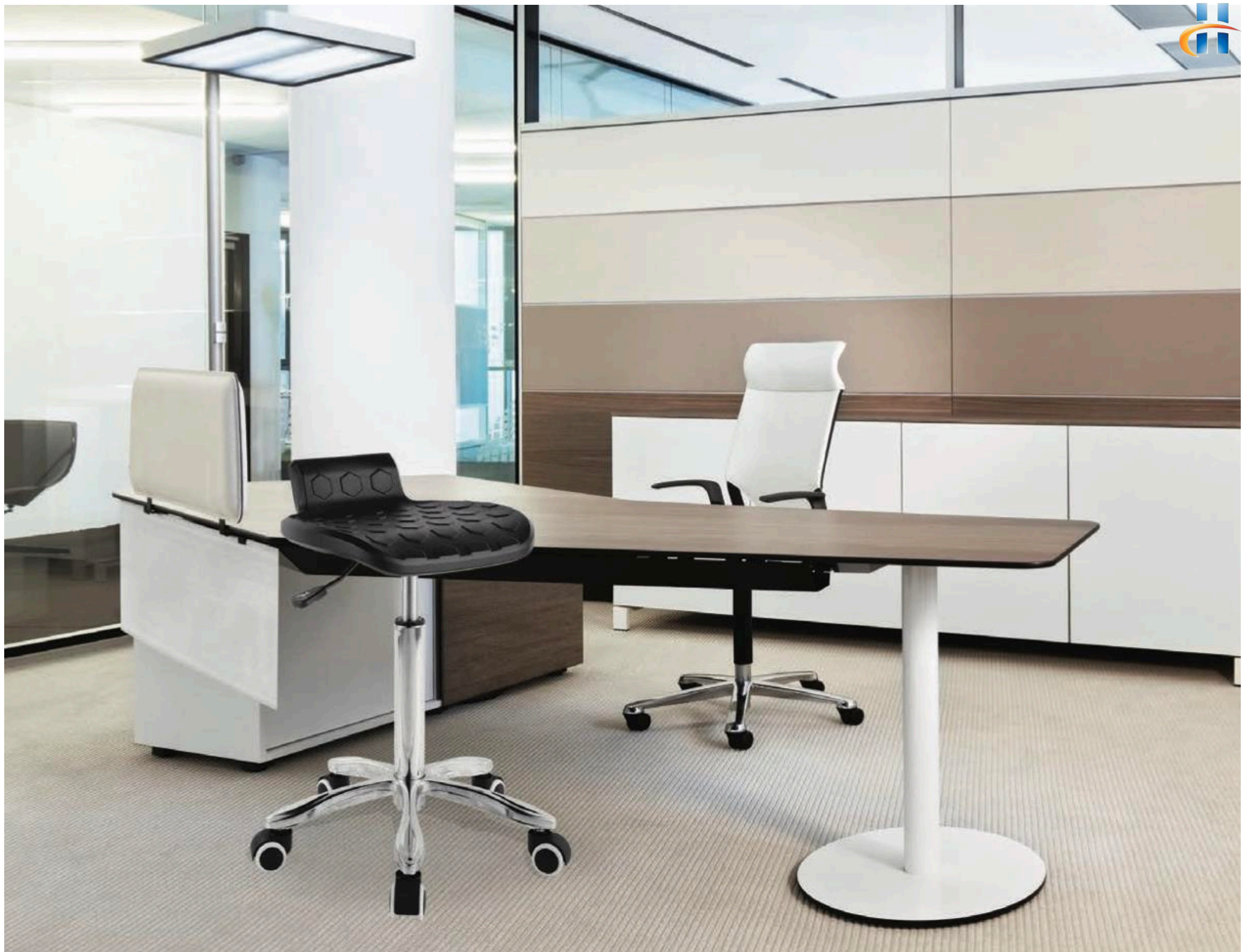

# CH03 PU

PU Integral- Self skinning Foam/Anti-static series

Unprecedented master work certainly manifest humanities, a mini-field of precision physics is permeated with palace-grade feeling, prosperous and grand, moving and unrestrained, the forerunners predict the future; the new generation demonstrates majestic demeanor.



## Model:CH03-1B-BU



### Colour





**CH03A**



**CH03B**



**CH03C**



**CH03J**



**CH03AS**



**CH03BS**



**CH03CS**



**CH03JS**



**CH03-1A**



**CH03-1B**



**CH03-1C**



**CH03-1J**



**CH03-1AS**



**CH03-1BS**



**CH03-1CS**



**CH03-1JS**



Model:CH04-1BS



Colour

BK	4204	8314	7721U	1807U	9093	4010	310C	2659	2706
----	------	------	-------	-------	------	------	------	------	------





**CH04AS**



**CH04BS**



**CH04CS**



**CH04JS**



**CH04A**



**CH04B**



**CH04C**



**CH04J**



**CH04-1AS**



**CH04-1BS**



**CH04-1CS**



**CH04-1JS**



**CH04-1A**



**CH04-1B**



**CH04-1C**



**CH04-1J**



# CH06 PU

PU Integral- Self skinning Foam/Anti-static series



## Integrate creativity

BOBAI Furniture brings endless creativity with science and technology. The modeling designs are created based on those decoration inspirations sourced from around the world. Elegant lines help you environment.





**CH06A**



**CH06B**



**CH06C**



**CH06D**



**CH06H**



**CH06-1A**



**CH06-1B**



**CH06-1C**



**CH06-1D**



**CH06H1**



**CH06AL**



**CH06BL**



**CH06CL**



**CH06DL**



**CH06HL**



**CH06-1AL**



**CH06-1BL**



**CH06-1CL**



**CH06-1DL**



**CH06-1J**



**Model:CH07-1A**



**Colour**

BK	4204	8314	7721U	1807U	9093	4010	310C	2659	2706





**CH07A**



**CH07B**



**CH07C**



**CH07D**



**CH07H**



**CH07-1A**



**CH07-1B**



**CH07-1C**



**CH07-1D**



**CH07H1**



**CH07AL**



**CH07BL**



**CH07CL**



**CH07DL**



**CH07HL**



**CH07-1AL**



**CH07-1BL**



**CH07-1CL**



**CH07-1DL**



**CH07-1J**





# CH10 PU

PU Integral- Self skinning Foam/Anti-static series

## Great pleasure brings beauty

The inspiration from nature is smooth and pretty. Imported quality materials, pure, primitive, soft and elastic; irresistible fascination suits man's nature, creating refreshing and elegant space environment, and reflects casual, relaxing and random office style.

### Model:CH10-1E





**CH10A**



**CH10B**



**CH10E**



**CH10-1G**



**CH10-1A**



**CH10-1B**



**CH10-1E**



**CH10-1J**

# CH15 PU

PU Integral- Self skinning Foam/Anti-static series



Unprecedented master work certainly manifest humanities, a mini-field of precision physics is permeated with palace-grade feeling, prosperous and grand, moving and unrestrained; the forerunners predict the future; the new generation demonstrates majestic demeanor.

## Model:CH15-1BS



### Colour





**CH15AS**



**CH15BS**



**CH15CS**



**CH15JS**



**CH15A**



**CH15B**



**CH15C**



**CH15J**



**CH15-1AS**



**CH15-1BS**



**CH15-1CS**



**CH15-1JS**



**CH15-1A**



**CH15-1B**



**CH15-1C**



**CH15-1J**





**Model:CH18-1G-RE**





**CH18A**



**CH18B**



**CH18E**



**CH18-1G**



**CH18-1A**



**CH18-1B**



**CH18-1E**



**CH18-1J**

# CH19 PU

PU Integral- Self skinning Foam/Anti-static series

Unprecedented master work certainly manifest humanities, a mini-field of precision physics is permeated with palace-grade feeling, prosperous and grand, moving and unrestrained; the forerunners predict the future, the new generation demonstrates majestic demeanor.



## Model:CH19-1BSF



### Colour





**CH19A**



**CH19B**



**CH19C**



**CH19J**



**CH19AS**



**CH19BS**



**CH19CS**



**CH19JS**



**CH19-1A**



**CH19-1B**



**CH19-1C**



**CH19-1J**



**CH19-1AS**



**CH19-1BS**



**CH19-1CS**



**CH19-1JS**



# CH24 PU

PU Integral- Self skinning Foam/Anti-static series

# Integrate creativity

BOBAI Furniture brings endless creativity with science and technology. The modeling designs are the created based on those decoration inspirations sourced from around the world. Elegant lines help you environment.



## Model:CH24-1D

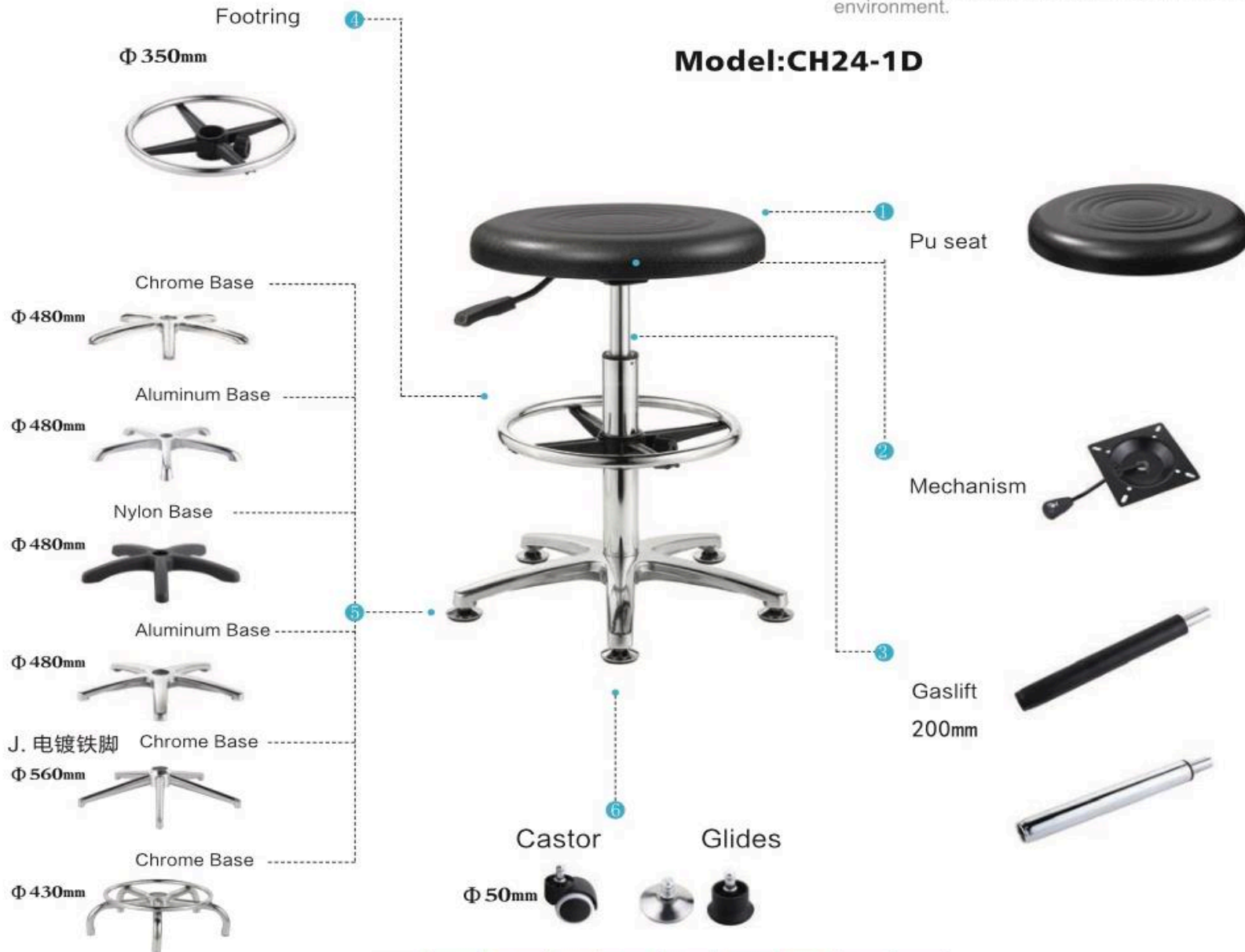

### Colour







**CH24A**



**CH24B**



**CH24C**



**CH24D**



**CH24H**



**CH24-1A**



**CH24-1B**



**CH24-1C**



**CH24-1D**



**CH24H1**



**CH24AL**



**CH24BL**



**CH24CL**



**CH24DL**



**CH24HL**



**CH24-1AL**



**CH24-1BL**



**CH24-1CL**



**CH24-1DL**



**CH24-1J**



# CH25 PU

PU Integral- Self skinning Foam/Anti-static series

## Great pleasure brings beauty



The inspiration from nature is smooth and pretty. Imported quality materials, pure, primitive, soft and elastic; irresistible fascination suits man's nature, creating refreshing and elegant space environment, and reflects casual, relaxing and random office style.

### Model:CH25-1E





**CH25A**



**CH25B**



**CH25E**



**CH25-1G**



**CH25-1A**



**CH25-1B**



**CH25-1E**



**CH25-1J**

# CH26 PU

PU Integral- Self skinning Foam/Anti-static series

## Model:CH26-1A



**Colour**

BK	4204	8314	7721U	1807U	9093	4010	310C	2659	2706



**CH26A**



**CH26B**



**CH26D**



**CH26-1A**



**CH26-1B**



**CH26-1D**



**CH26AL**



**CH26BL**



**CH26DL**



**CH26E**



**CH26J**



**CH26-1AL**



**CH26-1BL**



**CH26-1DL**



**CH26-1E**



**CH26-1J**

## Enjoy "sitting" on it

Swivel Chair keeps researching in ergonomics, and demonstrates a complete physical theory of chair that suits human body. Therefore swivel chair helps you keep healthy sitting, improves blood circulation, accelerates metabolism, relaxes the back and improves working efficiency.





# CUSTOMIZED

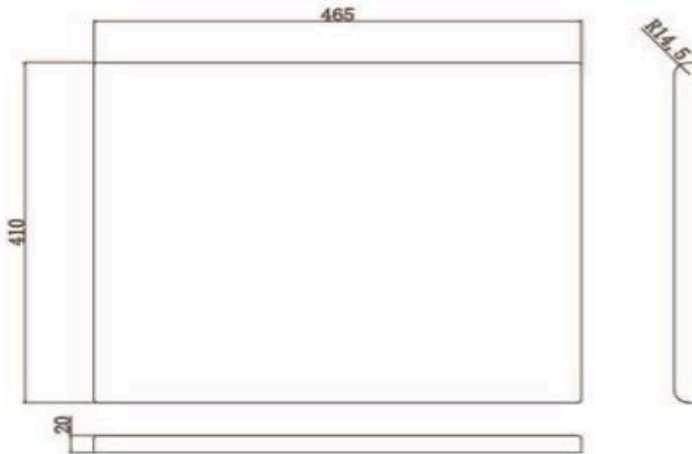

Our company specializes in processing of public seating/airport chair,welcome to customized design.



**Model:2695PU**  
**2695PU Integral-self skinning foam**



**Model:2691PU**  
**2691PU Integral-self skinning foam**



**Model:B2PU**  
**B2PU Integral-self skinning foam**

# CUSTOMIZED



Professional Manufacturer Polyurethane  
Public Seating/Airport Waiting Chair



## PU material



IT IS NOT CONDUCIVE TO BACTERIAL REPRODUCTION



IT HAS LITTLE AFFINITY WITH NON-POLAR MINERAL OIL



EXTREMELY LONG WORKING LIFE  
GOOD SOFTNESS & HIGH TENSILE STRENGTH



BK

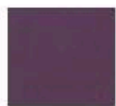

4204



8314



7721U



1807U



9093



4010



310C



2659



2706

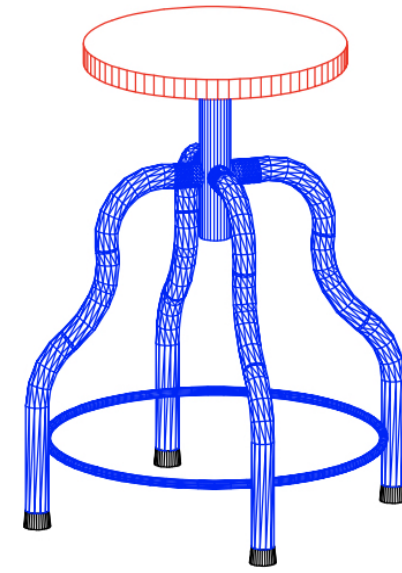
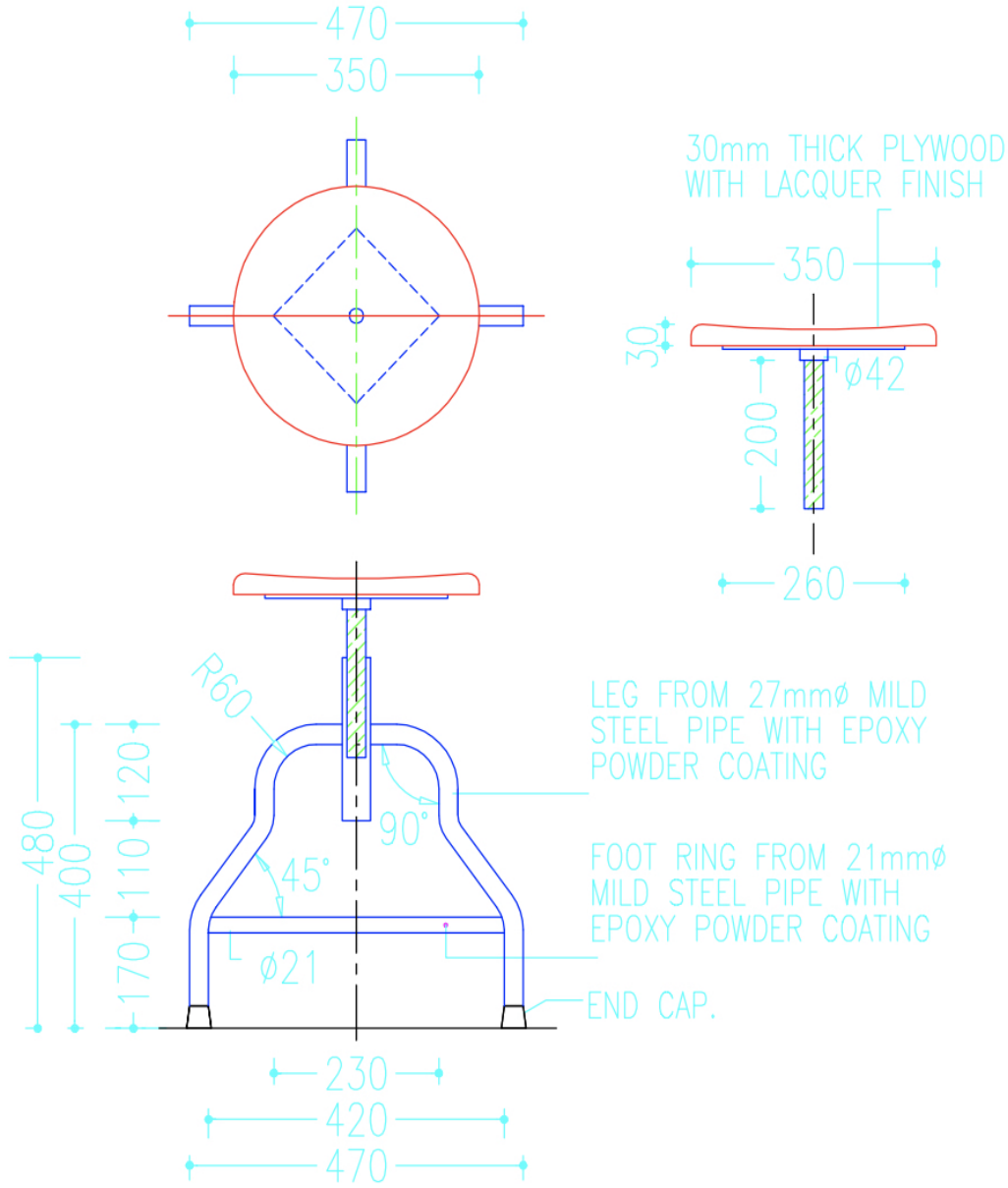

**PERSPECTIVE VIEW**  
**FOR LAB STOOL**





**Herais**  
Solutions



**Herais**  
Lab Solutions

**HERAIS INTERNATIONAL**

100 Bessemer Rd., London ON N6E 1R2 Canada

[www.herais.ca](http://www.herais.ca)

Tel: +1 519 800 1353

Email: [higtc@windowslive.com](mailto:higtc@windowslive.com)